

The PAC8000 PROFINET Scanner (PNS) module interfaces PAC8000 IO modules to a PROFINET IO-Controller. The PNS scans the modules in its node, retrieving input data and providing output data, and publishes input data on the PROFINET Network at the configured update rate. The PNS manages PROFINET communication and module configuration between an IO-Controller and IO modules attached to PNS. If network communications are lost, the PNS manages I/O states according to the individual IO module configurations.

The PNS is available in two variants to allow you to use the network media that meet the requirements of your application.

8515-BI-PN: Two 10/100 Mbps copper interfaces

8516-BI-PN: Two 100Mbps Multi-Mode fiber (MMF) ports

Above PNS modules require the following carrier to connect with 8000 IOs.

8752-CA-NS: PAC8000 Node Service Carrier

The PNS will provide all the functions, services and protocols required for certification as per PROFINET IO version 2.2.

8515-BI-PN/8516-BI-PN: PAC8000 PROFINET Scanner Module

Features

- Standard PROFINET alarm and diagnostics reporting.
- Supports configuration using Classless Inter Domain Routing (CIDR) with sub-netting and super-netting.
- Each PNS can be connected into a daisy-chain/line, star, or ring (redundant media) topology.
- Supports Media Redundancy Protocol (MRP) client mode operation.
- Supports Heart beat: Informs PROFINET Controller that PNS is active and functioning.
- Can be upgraded in the field; supports firmware updates via USB port.
- **Note:** The USB port is for firmware upgrades only. It is not intended for permanent connection.
- Compliant with EU RoHS directive using the following exemptions identified in the Annex: 7C-I & 7C-III

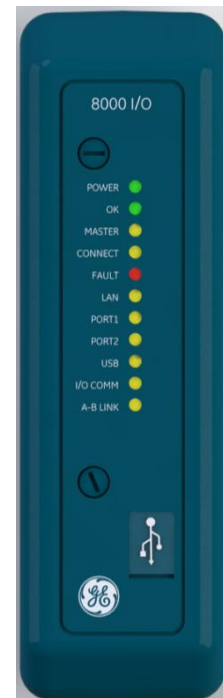

The PNS module's functions include:

- Scanning all directly connected input modules and writing to all directly connected output modules
- Publishing data onto the PROFINET IO-Controller at a customer-specified update rate.
- Receive data from a PROFINET IO-Controller at a customer-specified update rate.
- Managing PROFINET communication and IO module configuration between an IO-Controller and IO modules of PNS node.
- Managing the state of the I/O when communications is lost
- Publishing fault information (alarms, diagnostics, etc.) to IO-Controller

Specifications

PROFINET Support	PROFINET Version 2.2 Class A IO-Device	
RX3i PLC CPU Version Required	Firmware version 7.0 or later	
Proficy Machine Edition Version Required	Version 7.5 SIM 3 or later V2.2 GSDML and Proficy Machine Edition/3rd-Party tools.	
Power Requirements	8515-BI-PN 4.5 Watts (5.5 Watts Max) 8516-BI-PN 6.0 Watts (7.2 Watts Max)	
Module Dimensions	128.3mm X 160.3mm X 47.78mm (5.05" X 6.31" X 1.88")	
Module weight	150g	
Carrier Required	8752-CA-NS : PAC8000 Node Services Carrier	
Operating Temperature Range	8515-BI-PN -40°C to +70°C 8516-BI-PN -40°C to +70°C Horizontal DIN rail mounting. Optimum orientation is when the carrier is mounted in a vertical plane with field terminals for communication cables located below the modules.	
Number of Port Connectors	8515-BI-PN : Two RJ-45 8516-BI-PN : Two SC-Duplex	
USB Connector (for firmware upgrades)	One Micro-B connector. USB 2.0 compliant running at Full-speed (12 MHz)	
PNS Status and Control Bits	64 input status bits and 16 output control bits	
I/O Data Update on the PROFINET LAN	Configurable: 1ms, 2ms, 4ms, 8ms, 16ms, 32ms, 64ms, 128ms, 256ms and 512ms (Recommended is 4 ms and above)	
Number of IP addresses	One. Supports Classless Inter-Domain Routing (CIDR)	
Number of MAC Addresses	Three. One per external port and one internal. External MAC addresses are only used for specialized Ethernet protocols such as MRP or LLDP	
I/O Station Maximum Limits	Number of I/O Modules per Node	32
	I/O data per station	2880 bytes total 1440 bytes of input data 1440 bytes of output data
RoHS Compliance	Yes	
Configuration	Configured using Proficy Machine Edition when used with a PACSystems RX3i PROFINET Controller (PNC) module, as part of an RX3i PROFINET network. V2.3 GSDML file is available for import into 3 rd -Party tools.	
IO Carrier	8709-CA-08	

For PNS installation, configuration and operating information, refer to the PAC8000* IO *PROFINET Scanner User's Manual*, GFK-2839

LEDs

The PNS has eleven LEDs that indicate the presence of power and show the operating mode and status of the PNS.

Name	Color	Description
POWER	Green	ON = Power OK OFF = No power
OK	Green	ON = PNS is OK and completed system boot up successfully BLINK pattern = See table below for description
MASTER	Yellow	Not used in current release
CONNECT	Yellow	ON = One or more PROFINET application relationships (ARs) has been established OFF = No PROFINET application relationships (ARs) are established SLOW BLINK = The PROFINET Scanner has not been assigned a name.
FAULT	Red	ON = One of the configured IO module or PNS itself is in fault state SLOW BLINK = Invalid MAC addresses OFF = All configured IO modules are in healthy state
LAN	Yellow	IRREGULAR BLINK = Node is processing the packets addressed to it OFF = No activity
PORT 1	Yellow	ON = Link connected OFF = Link failure IRREGULAR BLINK = Activity on this port.
PORT 2	Yellow	ON = Link connected OFF = Link failure IRREGULAR BLINK = Activity on this port.
USB	Yellow	ON = USB connection is active, but no data is being transferred OFF = No activity on USB IRREGULAR BLINK = Activity on USB
I/O COMM	Yellow	ON = All IO module commands were successful in last two seconds OFF = No IO module command was sent in last two seconds IRREGULAR BLINK = At least one IO Module command failed in last two seconds
A-B LINK	Yellow	Not used in current release

LED Blink Patterns

Multiple LEDs can blink in patterns that indicate special conditions:

<i>Pattern Displayed</i>	<i>Description</i>
CONNECT, FAULT, LAN, PORT 1, PORT 2 LED's go ON in order, from bottom to top. After the top LED (CONNECT) has been ON for about 45 ms, the LEDs go Off from top to bottom, until all of the LEDs are Off. After all of the LEDs have been Off for about 45 ms, the pattern is repeated.	Module Identification Requested (Initiated by PME or any DCP client and is used to locate and/or identify a PROFINET Scanner)
CONNECT, FAULT, LAN, PORT 1, PORT 2 LED's blink slow (ON for 0.5 seconds, OFF for 0.5 seconds) in unison.	Firmware Update Mode (Application/FPGA)
MASTER, CONNECT, FAULT, LAN, PORT 1, PORT 2 LED's blink slow (ON for 0.5 seconds, OFF for 0.5 seconds) in unison.	Firmware Update Mode (Boot loader)
OK, CONNECT, FAULT, LAN, PORT 1, PORT 2	The CONNECT, FAULT, LAN, PORT 1 and PORT 2 LEDs flash once. The OK LED blinks an (2-digit hexadecimal) error code. The pattern is repeated until the module is reset or power-cycled.

8752-CA-NS PAC8000 Node Service Carrier

Features

- Accommodates two +12V Power Supplies
- Provides support for 12V (PNS power), 24V (Bussed Field Power) power fail monitoring
- Same size of 4-way IO carrier
- Can be used with DIN rail or panel mounting

Carrier Specifications

Hazardous Area Approvals	
Location of Node	Zone 2, IIC T4 hazardous area
Electrical	
Railbus connector	Male out
Ground Connection	M4 screw terminal (x1)
BFP0V Connection	M4 screw terminal (x1)
System Power Connections	6-pin (Male) Note: This does not provide power to the PNS module
Bussed Field Power (BFP) Fail Connector	12-pin (Male)
Environmental Requirements	
Ambient temperature: Operating	-40°C to 70°C
Storage	-40°C to 85°C
Relative humidity	5 to 95% (non-condensing)
Vibration and shock	See PAC8000 System Specification Data Sheet
Materials	
Carrier molding	Modified poly-phenylene oxide
Printed wiring board	Epoxy resin woven glass laminate (TBD)
Mechanical	
Dimensions (overall)	178 (w) x 170 (d) x 68 (h) mm
Weight (approximate)	450g
Mounting	Flat panel (two fasteners) or DIN rail
DIN rail types	"Top hat," 7.5 x 35 mm to EN 50022 .or 15 x 35 mm to EN 50022 or G-section, to EN 50035

Carrier Diagram

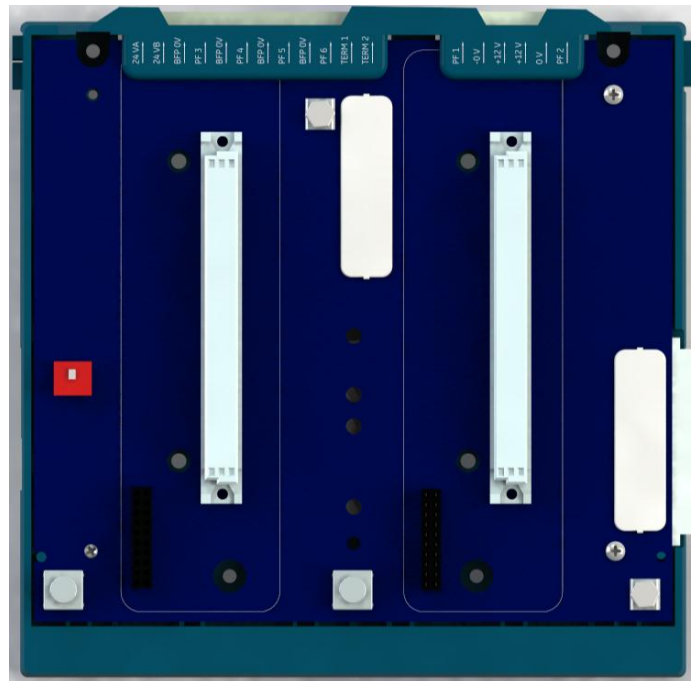

Ordering Information



8515-BI-PN	PAC8000 PROFINET Scanner Module, Two 10/100Mbps copper interface
8516-BI-PN	PAC8000 PROFINET Scanner Module, Two 100Mbps Multi-Mode fiber (MMF) ports
8752-CA-NS	PAC8000 Node Service Carrier

Supported IO Modules

8103-AI-TX	8 Channel Analog Input Module, single-ended 4-20 mA input channels
8104-AO-IP	8 Channel Analog Output Module, 4-20 mA single-ended outputs
8109-DI-DC	8 Channel Digital Input Module, 24 V DC, isolated, sinking.
8115-DO-DC	8 Channel Digital Output Module, 2-60 V DC, non-isolated, module powered
8110-DI-DC	8-channel Digital Input, 24 V dc, non-isolated, module powered
8111-DI-AC	8-channel Digital Input, 115 V ac, isolated, sinking
8112-DI-AC	8-channel Digital Input, 115 V ac, non-isolated, module powered
8113-DI-AC	8-channel Digital Input 230 V ac, isolated, sinking
8114-DI-AC	8-channel Digital Input, 230 V ac, non-isolated, module powered
8116-DO-AC	8-channel Digital Output, 20-265 V ac, non-isolated, module powered
8117-DO-DC	8-channel Digital Output, 2-60 V dc, isolated, unpowered
8118-DO-AC	8-channel Digital Output, 20-265 V ac, isolated, unpowered
8119-VI-05	8-channel Analog Input, 1-5 V

Installation in Hazardous Areas

The following information is for products bearing the UL marking for Hazardous Locations or ATEX marking for explosive atmospheres:

- EQUIPMENT LABELED WITH REFERENCE TO CLASS I, DIVISION 2, GROUPS A, B, C & D, HAZARDOUS LOCATIONS (ALTERNATIVELY MARKED AS CLASS I ZONE 2, GROUP IIC) IS SUITABLE FOR USE IN CLASS I, DIVISION 2, GROUPS A, B, C, D OR NON-HAZARDOUS LOCATIONS ONLY
- Equipment labeled with  II 3 G is suitable for use in Group 2 Category 3 environments.
- Connectors P1, J101 & HVCC shall be secured properly with the mechanical latch provided for the purpose.
- WARNING - EXPLOSION HAZARD - SUBSTITUTION OF COMPONENTS MAY IMPAIR SUITABILITY FOR CLASS I, DIVISION 2;
- WARNING - EXPLOSION HAZARD - WHEN IN HAZARDOUS LOCATIONS, TURN OFF POWER BEFORE REPLACING OR WIRING MODULES; AND
- WARNING - EXPLOSION HAZARD - DO NOT DISCONNECT EQUIPMENT UNLESS POWER HAS BEEN SWITCHED OFF OR THE AREA IS KNOWN TO BE NONHAZARDOUS.
-  WARNING - EXPLOSION HAZARD - USB PORT IS ONLY FOR USE IN NONHAZARDOUS LOCATIONS, DO NOT USE UNLESS AREA IS KNOWN TO BE NON-HAZARDOUS.

ATEX Marking

 II 3 G Ex nA IIC T5 -40°C · Ta · +70°C

(Ref. ATEX Cat-3 certificate# GE13ATEX8515X & GE13ATEX8516X from our support website for details of marking and installation guidelines.)

CE Marking

CE (EMC & ATEX Directives)

(Ref. Declaration of Conformity from our support website for details)

UL Marking

cULus LISTED FOR US and CANADA FOR HAZLOC & PROCESS CONTROL INSTRUMENTS CATEGORY

HAZLOC Classification

Class I Zone 2 Group IIC

Class I Division 2 Groups A, B, C, D

Quick Start

Installation and initial startup procedures for the PNS include the following steps. Before installing and operating the PNS, refer to the *PAC8000 PROFINET Scanner Manual*, GFK-2839

1. Pre Installation Check:

Upon receiving your PAC8000 PNS equipment, carefully inspect all shipping containers for damage. If any part of the system is damaged, notify the carrier immediately. The damaged shipping container should be saved as evidence for inspection by the carrier.

As the consignee, it is your responsibility to register a claim with the carrier for damage incurred during shipment. However, GE Intelligent Platforms will fully cooperate with you, should such action be necessary.

After unpacking the PAC8000 PNS equipment, record all serial numbers. Serial numbers are required if you should need to contact Customer Care during the warranty period. All shipping containers and all packing material should be saved should it be necessary to transport or ship any part of the system.

2. Installing PNS module on Carrier

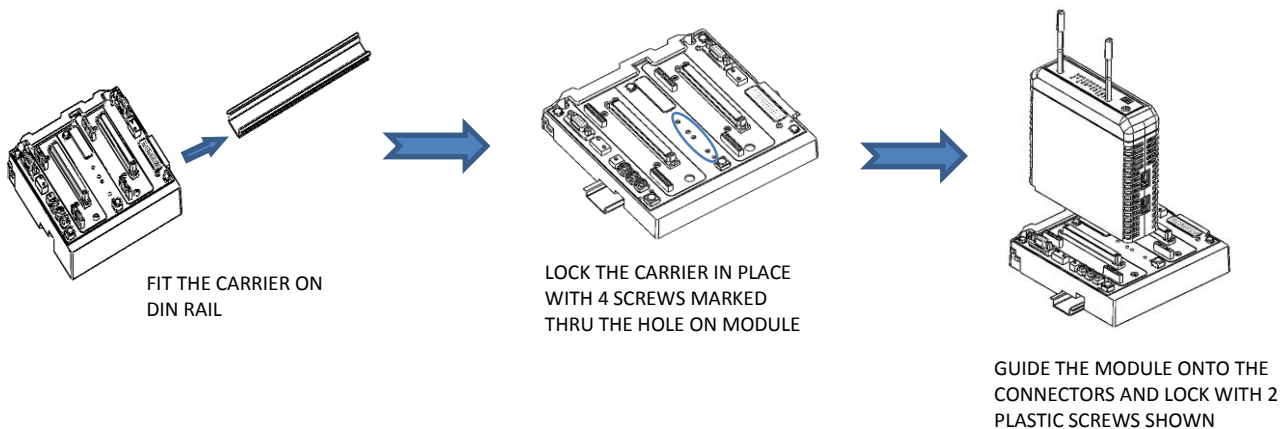

3. Connecting the PNS to the PROFINET network and to a 10BaseT, 100BaseTX or 1000BaseT IEEE 802.3 network for general Ethernet communications

Each port on a PAC8000 PNS operates independently (the ports are connected via an internal switch), so devices that operate at different speeds and/or duplex modes may be attached to the ports. Each port automatically detects the attached cable and functions properly with either straight-through or crossover cables.

Note: The PAC8000 PROFINET Scanner operates only in auto-negotiate mode. All PROFINET network devices and switches that are connected to the PAC8000 PROFINET Scanner should be configured to use auto-negotiation.

4. Installing the USB port driver (optional)

The PNS provides a micro USB port for connection to a computer running Windows 2000, Windows XP, Windows Vista, or Windows 7 operating system. The USB port is only used for firmware updates. USB driver files are provided as part of upgrade packages compatible with the PROFINET Scanner. The PNS includes a driver-install application that can be used to enable a computer to communicate with a PNS via its USB port.

5. Installing SFP devices:

Warning

Optical SFPs use an invisible laser to generate a fiber-optic signal. Always keep the port covered if a cable is not installed. Do not look into the open port if a cable is not installed.

Warning

If the surrounding air operating temperature of the PNS is greater than 40 °C (104 °F), SFP devices could have operating temperatures over 70 °C (158 °F). Under these conditions, for your safety, do not use bare hands to remove an SFP device from the SFP cage. Use protective gloves or a tool (needle-nose pliers) to avoid handling the hot SFP device directly when removing the SFP device.

6. Assigning an IO Device Name to the PNS

Before attempting to connect to or configure the PAC8000 PNS, the IO Device Name must be set with a Discovery and Configuration Protocol (DCP) tool, such as the Proficy Machine Edition Discovery Tool.

7. Configuring the PNS and its IO Modules on a PROFINET network

Proficy Machine Edition (or any 3rd party tool required by your IO Controller) is used to configure a PAC8000 PROFINET network. The configuration must match actual hardware present exactly or attempted PROFINET connections will result in a Loss of Device fault. The GSDML file, GSDML-V2.2-GEIP-PAC8000PNS-20130122.xml, for the PAC8000 PNS must be imported into Proficy Machine Edition (or 3rd part tool) in order to configure the PAC8000 PNS.

Supported Network Media Types and Distances

Media Type	Connector Type	Wavelength (nm)	Media Type	Core Size (µm)	Modal Bandwidth (MHz – Km)	Maximum Distance (m)
100BASE-FX	SC or SC-Duplex	1300	MMF	62.5	500	2 – 2,000 (Full-Duplex)
				50	400	
				50	500	2 – 400 (Half-Duplex)
10/100BASE-T	RJ45	-	CAT5/CAT5e/CAT6	-	-	100 (maximum)

PROFINET IO over wired infrastructure must be 100Mbps full-duplex or faster. The hardware is capable of operating at 10Mbps but should not be used for PROFINET unless it is PROFINET over wireless (802.11).

External Power Supply Connections

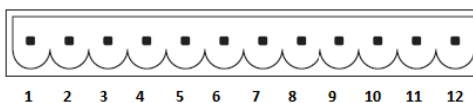

Terminal	Function
1	PF1: Power Fail Signal From PSU 1
2	0V Input (PSU 1)
3	+12V Input (PSU 1)
4	+12V input (PSU 2)
5	0V Input (PSU 2)
6	PF2: Power Fail Signal From PSU 2

BFP Monitor Connections

Terminal	Function
1	24VA: 24V from BFP PSU 1/2
2	24VB: 24V from BFP PSU 3/4
3	BFPOV
4	PF3: AUX signal from BFP PSU 1
5	BFPOV
6	PF4: AUX signal from BFP PSU 2
7	BFPOV
8	PF5: AUX signal from BFP PSU 3
9	BFPOV
10	PF6: AUX signal from BFP PSU 4
11	TERM1: (Reserved)
12	TERM2: (Reserved)

Important Product Information for this Release

Release History

Version	Firmware Release	Date	Comments
8515-BI-PN 8516-BI-PN	1.00	March 2013	Initial release

Compatibility

Subject	Description
Proficy Machine Edition Requirements	Proficy Machine Edition version 7.50 Build 5517P, SIM-3 and above
Upgrading From Previous Firmware Versions	N/A. Initial/First release.
Downgrade To Previous Firmware Versions	N/A. Initial/First release.

Problems Resolved in This Release

N/A (Initial release)

New Features and Enhancements

N/A (Initial release)

Restrictions and Open Issues

Subject	Description
PROFINET stack does not support IOCS (Input/Output Consumer Status).	The PROFINET stack used for this release does not support Input/Output Consumer Status at the application level. This means the PNS cannot inform the PNC whether the data sent to PNS is correctly consumed at the I/O module. In the opposite direction, the PNS is also not able to know whether the data sent from PNS is correctly consumed at the CPU. The primary impact of this is that the PNS does not set point faults in the CPU for operational faults
PNS rejects setting its subnet mask & gateway to 0.0.0.0	The PNS does not support a subnet mask of 0.0.0.0. When a hardware configuration with LAN subnet mask address set to 0.0.0.0 is downloaded to the RX3i system, the PNS will fail to connect to the PNC.
PNS does not generate an alarm when MRP domain name is mismatched	When the PNS is configured as a Client to a third-party Media Redundancy Manager and the domain names do not match, the PNS does not report an alarm. User should be careful while setting the domain name and should not assign different domain names to IO controller and PAC8000 PNS associated with it. Neglecting this leads to failure in reporting alarms.

Operational Notes

Subject	Description
Ethernet port operation	The PROFINET Scanner requires at least one network to be operating at full duplex for a connection to remain established. The PROFINET protocol may be sent and received over either or both of the two external ports. Devices connected to the PROFINET Scanner ports should have Ethernet Autonegotiation enabled unless the IO-Controller supports configuring the port operation mode. If the IO-Controller configures the PROFINET Scanner port to a specific setting with autonegotiation disabled, the device connected to the PROFINET Scanner must be configured for exactly the same setting.
USB port drivers	When connecting the USB cable to the PROFINET Scanner, you may receive a warning for installing a driver that has not passed Windows Logo testing. Each PROFINET Scanner is recognized as a separate Windows device with separate installation as each has a unique serial number. This is normal operation for this release.
Network parameters for IO-Devices	If the network parameters (IP Address, subnet mask, and gateway IP) assigned by the DCP tool are different from the configuration in the IO-Controller and the IO-Controller is configured to assign IP settings to devices, when the IO Controller assigns its IP settings, the settings previously stored from the DCP tool are lost. On a reset, the IO-Device is set to factory default values (0.0.0.0/0.0.0.0/0.0.0.0) as prescribed by the PROFINET specification.
On configuration download, only one configuration error per module is reported even though it has multiple errors.	On configuration download, when PNS detects first configuration fault, it reports the fault and continues verifying configuration faults of next IO module. It will not report the second fault of that module until the first configuration fault is addressed. This saves flooding system with configuration faults.
Configuration mismatch logged twice when downloaded configuration does not match with the physical module on setup.	When configuration is downloaded to PNS first time after power-up, if downloaded configuration does not match with physical IO module, PNS reports "system configuration mismatch" fault and also resets the corresponding IO module to bring it to default state. Reset of IO module causes logging of additional fault "loss of IO module" and re-reporting of "system configuration mismatch".